



# Product range

2019/20

---

Concrete sealing system

# Whatever you're building - we provide the reassurance.



**For more than 80 years the SCHOMBURG group has developed, produced and distributed construction systems and products for the areas of:**

- Sealing/repairs to buildings
- Tiles/natural stone/screed application
- Ground protection/floor coating systems
- Concrete technology

SCHOMBURG stands for a broad range of product systems offering a solution for almost any requirement or any problem. The solution certainly highlights the double benefit that constitutes the core of the brand: SCHOMBURG is sure to offer a solution for every problem - and this with products that provide the architects and fabricators with maximum safety.

Characterised by a quality and environmental awareness anchored firmly in the culture of the family business, we develop and produce high-quality construction materials systems.

A performance promise stands behind the medium-sized SCHOMBURG company, both with the family that owns it and the committed team of employees. We seal this promise for all of the users of our products with the "Burg" [castle] upon which everyone can symbolically build.

We provide local support for our customers with our competent field staff and technical service team. Intensive training of our fabricators and trade partners enables us to achieve secure construction performance with high processing quality. SCHOMBURG understands that good market partnerships and secure construction performance also require more than just the provision of product systems. Tailored construction solutions with special finishing details, which can only be found with SCHOMBURG, the on-site guidance with challenging applications, processing techniques for increased economic efficiency and guarantees far beyond the legal

requirements, are just a few examples of the services provided.

SCHOMBURG GmbH distribution is implemented via the construction materials and tiling wholesale trade. Innovative processes and products are therefore available to a wide target group throughout Germany. Individual training concepts for architects and engineers, executing trades and specialist retainers complete the product range. Innovative processes and products provide an important contribution for simple and safe working processes. As with everything in life, everything is never complete and perfect all of the time. Everything is in flux and there are always new ideas and requirements arising in the market. SCHOMBURG strives to implement these as soon as possible with their customers and so it is often possible to be a step ahead of the competitors. This results in a competitive advantage for our customers too.

But it is not just the new, the well-proven systems also continue to impress by providing safe and long-lasting construction solutions, in some cases for more than 50 years. Brands like AQUAFIN®, COMBIFLEX®, ASODUR®, ASOCRET, THERMOPAL® and UNIFIX® define the market. Thanks to continuous quality adaptations and simplified applications, these product systems are the guarantee for success in the German and international marketplace.

We would be delighted to contribute to your success too.



Category	Page
<b>CONCRETE SEALING SYSTEM</b>	<b>4</b>
Crystalline interior waterproofing	4
Crystalline restructuring and exterior waterproofing	6
Waterproofing materials – construction joints	7
Waterproofing materials – movement joints	13
Waterproofing materials – sheet membranes	14
Pipe penetrations	15
Concrete restoration	16
Products listed by name	18
Products listed by product groups	18
We are there for you	19
Explanation of the pictograms and abbreviations	19



# CONCRETE SEALING SYSTEM

■ Crystalline interior waterproofing

CONCRETE SEALING SYSTEM

## BETOCRETE-CP360-WP

Crystalline waterproofing admixture with hydrophobic effects



- Crystalline admixture for integral waterproofing.
- Powder form.
- Innovative 2 in 1 technology.
- Crystallisation of the concrete structure.
- Crack healing up to 0.5 mm.
- Hydrophobic effect.
- Certified to EN 934-2:T 9.



Consumption:  
0.75 - 1.25 % based on CEM weight



	Article-No.	Color	Packaging size	Unit/Pallet
Decreases capillary water absorption.	2 06446003	grey	700 kg	1
	2 06446002	grey	17 kg	42

## BETOCRETE-CP350-CI

Crystalline concrete additive with corrosion inhibitors



- Crystalline admixture for integral waterproofing.
- Powder form.
- Innovative 2 in 1 technology.
- Crystallisation of the concrete structure.
- Crack healing up to 0.5 mm.
- Contains corrosion Inhibitors.
- For sale outside the EU only as the product is not CE marked.



Consumption:  
0.75 - 1.25 % based on CEM weight



	Article-No.	Color	Packaging size	Unit/Pallet
Containing additional corrosion inhibitor.	2 06445001	grey	20 kg	42

## BETOCRETE-CP351-CI

Crystalline concrete additive with corrosion inhibitors







- Crystalline admixture for integral waterproofing.
- Powder form.
- Innovative 2 in 1 technology.
- Crystallisation of the concrete structure.
- Crack healing up to 0.5 mm.
- Contains corrosion Inhibitors.
- For sale outside the EU only as the product is not CE marked.







Consumption:  
0.75 - 1.25 % based on CEM weight



	Article-No.	Color	Packaging size	Unit/Pallet
Containing additional corrosion inhibitor.	2 06457001	grey	20 kg	42



<b>BETOCRETE-CL210-WP</b>						
Crystalline waterproofing admixture with hydrophobic effects						
	<ul style="list-style-type: none"> <li>• Crystalline admixture for integral waterproofing.</li> <li>• Liquid.</li> <li>• Innovative 2 in 1 technology.</li> <li>• Crystallisation of the concrete structure.</li> <li>• Crack healing up to 0.5 mm.</li> <li>• Hydrophobic effect.</li> <li>• Certified to EN 934-2:T 9.</li> </ul> <p>Consumption: 1.75 - 2.25 % based on CEM weight</p>					
	  					
	Article-No.	Color	Packaging size	Unit/Pallet		
Easy to use liquid concrete additive.	2 06444003	white	1040 kg	1		
	2 06444002	white	220 kg	2		
	2 06444001	white	25 kg	24		



<b>BETOCRETE-CL170-P</b>						
Crystalline waterproofing admixture with plasticizing effect						
	<ul style="list-style-type: none"> <li>• Crystalline admixture for integral waterproofing.</li> <li>• Liquid.</li> <li>• Innovative 2 in 1 technology.</li> <li>• Crystallisation of the concrete structure.</li> <li>• Crack healing up to 0.5 mm.</li> <li>• Plasticizing effect.</li> <li>• Certified to EN 934-2:T 2.</li> </ul> <p>Consumption: 1.75 - 2.25 % based on CEM weight</p>					
	  					
	Article-No.	Color	Packaging size	Unit/Pallet		
Easy to use liquid concrete additive.	2 06443003	Colourless - clear	1100 kg	1		
	2 06443002	Colourless - clear	220 kg	2		
	2 06443001	Colourless - clear	25 kg	24		



# CONCRETE SEALING SYSTEM



■ Crystalline restructuring und exterior waterproofing



CONCRETE SEALING SYSTEM

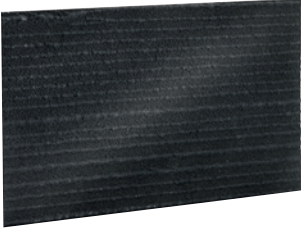

AQUAFIN-IC					
Crystalline waterproofing slurry					
	<ul style="list-style-type: none"> <li>• Cementitious, capillary active waterproofing slurry for the secure waterproofing of concrete substrates also against negative water pressure.</li> <li>• External and internal waterproofing in cellars, lift pits, foundations, pile foundations, floor slabs etc.</li> <li>• Waterproofing of containers for potable and service water, retaining tanks, water treatment plants and similar.</li> <li>• Waterproofing beneath screeds (unbonded or floating screeds).</li> <li>• Approved for potable water structures according to DVGW W270, W347.</li> </ul> <p>Consumption: approx. 0.75 - 1.5 kg/m<sup>2</sup></p>				
					
	Article-No.	Color	Packaging size	Unit/Pallet	
Waterproofing slurry with deep penetration of concrete.	2 04220001	grey	25 kg	42	

FIX 20-T					
Rapid setting swellable waterproofing membrane and plugging mortar					
	<ul style="list-style-type: none"> <li>• Chloride free, without corrosion promoting substances.</li> <li>• Highly reactive rapid mortar.</li> <li>• Strong bond to concrete substrates.</li> <li>• Rapid setting - also under water.</li> <li>• Compatible with the crystalline waterproofing system AQUAFIN-IC.</li> <li>• For interior and exterior use.</li> </ul> <p>Consumption: approx. 2 kg per litre of void</p>				
					
	Article-No.	Color	Packaging size	Unit/Pallet	
	2 01817001	cement grey	6 kg	85	
	2 01817002	cement grey	20 kg	32	

ASOCRET-IM					
Repair mortar with crystalline sealing action for concrete					
	<ul style="list-style-type: none"> <li>• Capillary active mortar.</li> <li>• For the watertight filling of opened cracks and holes, which are subsequently to be covered with AQUAFIN-IC. Alternatively ASOCRET-IM can also be used to form coved fillets.</li> </ul> <p>Consumption: U-shaped cracks chiselled out to 20 x 25 mm, 1.3 kg/m. Coved fillets 38 mm haunches: approx. 1.3 kg/m.</p>				
					
	Article-No.	Color	Packaging size	Unit/Pallet	
Also suitable under negative water pressure.	2 05523001	grey	25 kg	42	

AQUAFIN-CJ5						
Crystalline sheet waterstop, 15cm x 200cm						
	<ul style="list-style-type: none"> <li>• A crystalline sheet waterstop, which forms a permanent crystalline bond that fuses with the concrete.</li> <li>• Crystallization (self-healing) of the construction joint.</li> <li>• Simple handling.</li> <li>• No protective film to remove.</li> <li>• Overlaps can be formed with retaining clips.</li> </ul> <p>Consumption: approx. 1.05 m / m</p> 					
	Article-No.	Color	Packaging size	Unit/Pallet		
Crystalline joint sheet waterstop with self-healing effect.	2 05470001	grey	100 m / box x 15 cm / 2 m (incl. 50 Holding clamps)			

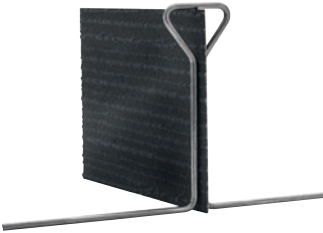
HOLDING CLAMP						
Joining Clamp for joint sheet waterstops						
	<ul style="list-style-type: none"> <li>• System accessory for crystalline sheet waterstop AQUAFIN-CJ5 (50 pieces are included in every package of AQUAFIN-CJ5).</li> <li>• Time-saving assembly.</li> </ul>					
	Article-No.	Color	Packaging size	Unit/Pallet		
	2 05471001		50 pieces			

OMEGA-HOLDER						
Holding clamp for joint sheet waterstops						
	<ul style="list-style-type: none"> <li>• System accessory for crystalline sheet waterstop AQUAFIN-CJ5.</li> <li>• Time-saving assembly.</li> </ul>					
	Article-No.	Color	Packaging size	Unit/Pallet		
	2 05472001		100 pieces			

# CONCRETE SEALING SYSTEM

Waterproofing materials – construction joints

## AQUAFIN-CJ1

Injection tube for waterproofing construction joints in concrete



- For the injection of all suitable injection resins, gels and acrylates, pressure watertight.
- Officially approved for use in the system with AQUAFIN-P4.
- Internal diameter: 6 mm, external diameter: 11 mm.



	Article-No.	Color	Packaging size	Unit/Pallet
For injection we recommend AQUAFIN-P4.	2 07201001	blue		50

## AQUAFIN-CJ-SET

Complete set incl. 10 m injection tubes



- Accessory product incl. 10 m injection tube.
- **Set 1** contents: 10 m AQUAFIN-CJ1, each 20 cm ventilation tube: red and white incl. connector, 1 isolation box, injection valve, tube clamp, 2 x 10 cm heat shrinking tubes, 2 plugs, 1 tube PVC-glue, 60 plastic clips. All parts are pre-assembled.
- **Set 2** contents: 10 m AQUAFIN-CJ1, 2 standard packers incl. injection nozzle, 60 plastic clips, 2 tube clamps.



	Article-No.	Color	Packaging size	Unit/Pallet
Tube and ancillary product for the installation of 10 m AQUAFIN-CJ injection tube system.	2 07220001		1 piece	
	2 07221001		<b>Set 1</b> 1 piece <b>Set 2</b>	

## AQUAFIN-P1

PU-injection resin for water-bearing cracks





- 1 component PU-injection resin for sealing water-bearing cracks.
- Ready to use, foams quickly with high volume increase offering high resistance.



Consumption:  
Dependent on the application.





	Article-No.	Color	Packaging size	Unit/Pallet
For waterproofing water bearing cracks.	2 05090002	brown	5.5 kg	100
	2 05090001	brown	1.1 kg (1.1 kg x 6 /box)	240



AQUAFIN-P4					
Elastic PU-injection resin					
	<ul style="list-style-type: none"> <li>• 2 component elastic PU-injection resin.</li> <li>• Slow reaction time, hardening to a viscoelastic pore-free material.</li> <li>• Advantageous application by means of suitable injection pumps.</li> <li>• Officially approved as a system with AQUAFIN-CJ1 (injection tube).</li> </ul> <p>Consumption: Dependent on the application.</p>				
					
	Article-No.	Color	Packaging size	Unit/Pallet	
For the injection as part of a system with AQUAFIN-CJ1.	2 05091005	yellow/brown	10.5 kg (5 kg/canister) (5.5 kg/canister)	100 100	
	2 05091004	yellow/brown	2.1 kg (1 kg × 6 / box) (1.1 kg × 6 / box)	240 240	

AQUAFIN-CJ3					
Bentonite waterstop with patent.					
	<ul style="list-style-type: none"> <li>• Super-Bentonite-Waterstop with a special delayed swelling coat and with an especially high sodium bentonite content (&gt; 70 %).</li> <li>• Officially approved for use in construction.</li> <li>• Thickness: 18 mm, width: 24 mm.</li> </ul>				
					
	Article-No.	Color	Packaging size	Unit/Pallet	
For fastening we recommend a mounting mesh.	2 07203001	black	5 m (6 roll / box)	144	

AQUAFIN-CJ4					
Bentonite waterstop with patent. Protective coating against rain.					
	<ul style="list-style-type: none"> <li>• Super-Bentonite-Waterstop with a special delayed swelling coat and with an especially high sodium bentonite content (&gt; 70 %).</li> <li>• Unique patented rain protection coating for installation regardless of weather conditions.</li> <li>• Officially approved for use in construction.</li> <li>• Thickness: 18 mm, width: 24 mm.</li> </ul>				
					
	Article-No.	Color	Packaging size	Unit/Pallet	
For fastening we recommend a mounting mesh.	2 07204001	black	5 m (6 roll / box)	144	

# CONCRETE SEALING SYSTEM

Waterproofing materials – construction joints

## AQUAFIN-CJ6

Thermoplastic expanding jointing band for waterproofing construction joints



- Elastic application.
- Rapid and intense swelling.
- Completely dimensionally stable even at high temperatures.
- Swelling process inexhaustible and often reversible.
- Suitable for fresh water and salt water.
- Suitable for riparian zones.
- Certified general technical approval.
- Thickness: 5 mm, width: 20 mm.



	Article-No.	Color	Packaging size	Unit/Pallet
For fixing we recommend the mounting adhesive.	2 07222001	red	40 m (5 roll/box)	100

## FASTENING MESH

Fastening mesh for expanding waterstops



- For fastening the bentonite expanding waterstop AQUAFIN-CJ3 or AQUAFIN-CJ4 on to concrete.



	Article-No.	Color	Packaging size	Unit/Pallet
Ancillary product for installing AQUAFIN-CJ4.	2 07216001		1 m (1 m × 20/box)	720

## AQUAFIN-CA

Mounting adhesive for swellable waterstops and for intermediate bonds / overlaps in bonded fresh concrete systems



- For adhering areas of overlap in bonded fresh concrete systems such as AQUAFIN-WM12.
- For bonding swellable waterstops such as AQUAFIN-CJ3, AQUAFIN-CJ4, and AQUAFIN-CJ6 on concrete.
- Solvent free.
- Silicone and isocyanate free.



	Article-No.	Color	Packaging size	Unit/Pallet
	2 07212001	grey	290 ml (290 ml × 20/box)	1200

## AQUAFIN-EJ-WR/WHF

PVC Joint Tape



- PVC joint tape for construction joints.
- Available in external and internal angles.
- High tensile strength.
- $\geq 275\%$  elongation at break.
- Can be welded with welding apparatus or welding blade / welding axe.

Consumption:  
approx. 1 m/m



Article-No.	Color	Packaging size	Unit/Pallet
2 05954001 - AQUAFIN-EJ-WHF-D-240	green	24 cm / 25 m	250
2 05954002 - AQUAFIN-EJ-WHF-D-300	green	30 cm / 20 m	160
2 05954003 - AQUAFIN-EJ-WR-D-300	green	30 cm / 20 m	160

## ASO-JOINT-TAPE-2000-S

Special waterproof tape for more demanding situations and heavy duty use



- High quality composite, elastic, extremely tear-proof, waterproof, vapour permeable. Ensures the quick drying of water containing tile adhesives and waterproof coatings, high resistance to aggressive materials.
- For the watertight construction of expansion and construction joints within waterproof coatings produced with e.g. SANIFLEX, SANIFIN, AQUAFIN-1K-PREMIUM, AQUAFIN-2K/M-PLUS, AQUAFIN-RS300 and ASOFLEX-AKB e.g. in swimming pools, subterranean car parks and areas in contact with the ground.
- Technically approved as a system with waterproofing materials.
- Very low emissions - GEV EMICODE EC1 PLUS.
- Auxiliary material in accordance with DIN 18533.

Width: Dependent on the customer's needs, special sizes from 50 cm to 100 cm wide can be produced in the factory.



Article-No.	Color	Packaging size	Unit/Pallet
2 05939002	white	20 cm / 50 m (4 roll / box)	96
2 05939001	white	20 cm / 25 m (6 roll / box)	144
2 05939003	white	12 cm / 50 m (8 roll / box)	192
2 05939004	white	1 m <sup>2</sup> <b>(width)</b> (50–100 cm)	

Thin section for low build up thickness, highly elastic and resistant to chemicals.

# CONCRETE SEALING SYSTEM

■ Waterproofing materials – movement joints

## AQUAFIN-EJ-WH/WRH

PVC Joint Tape



- PVC joint tape for construction joints.
- Available in external and internal angles.
- High tensile strength.
- $\geq 275$  % elongation at break.
- Can be welded with welding apparatus or welding blade / welding axe.

Consumption:  
approx. 1 m/m



Article-No.	Color	Packaging size	Unit/Pallet
2 05958001 - AQUAFIN-EJ-WH-D-240	green	24 cm / 25 m	250
2 05958002 - AQUAFIN-EJ-WH-D-300	green	30 cm / 20 m	160
2 05958003 - AQUAFIN-EJ-WRH-D-300	green	30 cm / 20 m	160

## AQUAFIN-EJ

PVC movement joint tape

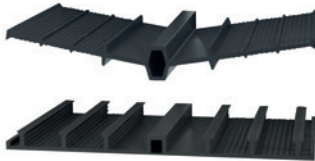





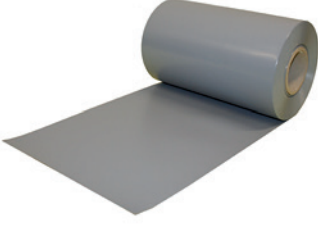

- PVC joint tapes for movement joints.
- External and internal variants available.
- High tensile strength.
- $\geq 275$  % elongation at break.
- Can be welded with welding apparatus or welding blade / welding axe.

Consumption:  
approx. 1 m/m



Article-No.	Color	Packaging size	Unit/Pallet
2 05957001 - AQUAFIN-EJ240I	black	24 cm / 25 m	125
2 05957002 - AQUAFIN-EJ320I, internal	black	32 cm / 25 m	100
2 05957003 - AQUAFIN-EJ320O, external	black	32 cm / 25 m	100

ASO-TAPE					
Thermo-plastic tape for waterproofing joints					
	<ul style="list-style-type: none"> <li>• Highly flexible.</li> <li>• Simple, uniform welds.</li> <li>• No activation needed.</li> <li>• Impermeable to water even under negative pressure.</li> <li>• Resistant to frost, UV and ageing. Certified technical approval.</li> </ul>				
					
	Article-No.	Color	Packaging size	Unit/Pallet	
Use for bonding ASODUR-K4031.	2 06427002	grey	1 mm (20 cm /20 m) = 20 m (200 × 1 mm)	48	
	2 06427004	grey	1 mm (30 cm /20 m) = 20 m (300 × 1 mm)	36	
	2 06427007	grey	2 mm (20 cm /20 m) = 20 m (200 × 2 mm)	48	
	2 06427009	grey	2 mm (30 cm /20 m) = 20 m (300 × 2 mm)	36	
	2 06427010	grey	2 mm (50 cm /20 m) = 20 m (500 × 2 mm)	24	

ASODUR-K4031					
Solvent-free, thixotropic 2 component universal epoxy adhesive					
	<ul style="list-style-type: none"> <li>• Bonds concrete to concrete.</li> <li>• High tensile adhesion strength.</li> <li>• High compressive and flexural strength.</li> <li>• Resistant to diluted acids, alkalis, solutions aggressive to concrete.</li> <li>• Good deformability at low temperatures.</li> <li>• Bonds to damp substrates.</li> <li>• Hardens without shrinkage.</li> <li>• Tested in accordance with DIN EN 1504-4.</li> <li>• Water impermeable up to 5 bar (DIN EN 12390-8).</li> </ul> <p>Consumption: approx. 1.70 kg/m<sup>2</sup> mm thickness</p>				
					
	Article-No.	Color	Packaging size	Unit/Pallet	
Non-slump formulation, tested to DIN EN 1504-4.	2 06409001	grey	6 kg (4 kg / bucket) (2 kg / bucket)	85 85	

CONCRETE SEALING SYSTEM

# CONCRETE SEALING SYSTEM

Waterproofing materials – sheet membranes

## AQUAFIN-WM12

Bonded system for fresh concrete, PVC 1.2 m x 25 m (30m<sup>2</sup>)



- PVC composite sheet for fresh concrete, which fuses with the concrete forming a secure bond without back-flow.
- Tough and easy to install.
- Light and simple handling, low loss due to overlaps.
- CE certified.
- Overlaps can be bonded and/or welded.

Consumption:  
approx. 1.1 m<sup>2</sup> / m<sup>2</sup>



Article-No.	Color	Packaging size	Unit/Pallet
2 07230001	transparent	1.2 m x 25 m	12

## AQUAFIN-CA

Mounting adhesive for swellable waterstops and for intermediate bonds / overlaps in bonded fresh concrete systems







- For adhering areas of overlap in bonded fresh concrete systems such as AQUAFIN-WM12.
- For bonding swellable waterstops such as AQUAFIN-CJ4 and AQUAFIN-CJ6 on concrete.
- Solvent free.
- Silicone and isocyanate free.



Article-No.	Color	Packaging size	Unit/Pallet
2 07212001	grey	290 ml (290 ml /cartridge × 20 / box)	1200

CONCRETE SEALING SYSTEM

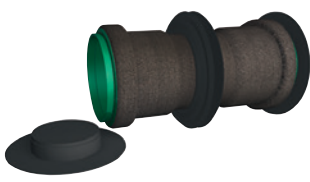
<b>AQUAFIN-PP-F</b>					
Penetrations for the construction of waterproof concrete tanks					
	<ul style="list-style-type: none"> <li>• For connecting waste water pipework and/or high temperature pipework.</li> <li>• Includes protective cover during the construction phase of nominal diameter 250.</li> <li>• Sealing profile for approx. 12 cm.</li> <li>• Gastight.</li> <li>• Tested to 5 bar.</li> </ul>				
	Article-No.	Color	Packaging size	Unit/Pallet	
Floor pipe penetration with a firm bond to the concrete.	2 05952001	black	DN110 / 50 cm		
	2 05952002	black	DN160 / 50 cm		
	2 05952003	black	DN200 / 50 cm		

<b>AQUAFIN-PP-W</b>					
Penetrations for the construction of waterproof concrete tanks					
	<ul style="list-style-type: none"> <li>• For connecting waste water pipework and/or high temperature pipework.</li> <li>• Includes protective cover for use during the construction phase up to nominal diameter 250.</li> <li>• Watertight profile to approx. 12 cm.</li> <li>• Gastight.</li> <li>• Tested to 5 bar.</li> </ul>				
	Article-No.	Color	Packaging size	Unit/Pallet	
Wall pipe penetration with a firm bond to the concrete.	2 05953001	black	DN110 / 24 cm		
	2 05953002	black	DN110 / 30 cm		
	2 05953003	black	DN110 / 36 cm		
	2 05953004	black	DN160 / 24 cm		
	2 05953005	black	DN160 / 30 cm		
	2 05953006	black	DN160 / 36 cm		
	2 05953007	black	DN200 / 24 cm		
	2 05953008	black	DN200 / 30 cm		
	2 05953009	black	DN200 / 36 cm		

# CONCRETE SEALING SYSTEM

■ Concrete restoration

## ASOCRET-KS/HB

Mineral-based corrosion inhibitor and bonding agent.



- Tested to DIN EN 1504-7.
- As a corrosion inhibitor for bare and shot-blasted metal reinforcement.
- As a bonding agent in concrete renovation and for the INDU-Monolith system as well as INDU-Drain.
- Frostproof.
- Resistant to alkaline hydrolysis.

Consumption:  
 Bonding agent: 1.5 kg/m<sup>2</sup>/mm  
 Corrosion inhibitor (twice): 1.6 kg/m<sup>2</sup>/mm



	Article-No.	Color	Packaging size	Unit/Pallet
As a bonding agent for ASOCRET-BIS-5/40.	2 05550003	grey	25 kg / bag	42
	2 05550004	grey	6 kg / bucket	85

## ASOCRET-BIS-5/40

Repair mortar for voids from 5–40 mm



- Tested to DIN EN 1504-3.
- Cement-based, chloride free re-profiling mortar for vertical and horizontal surfaces.
- Impedes the penetration of CO<sub>2</sub>.
- Water impermeable.
- Water vapour permeable.
- Resistant to frost and de-icing salts.
- Used for horizontal, vertical and „over head“ areas as an anti-sag re-profiling mortar for voids from 5–40 mm. Thicknesses up to 20 mm are possible as a single layer. Largest particle size: 2 mm.
- As a levelling mortar in swimming pool areas and pool tank construction.
- Can be trowel applied or sprayed with suitable equipment.



ASOCRET-BIS-5/40 is a system component and is to be used in combination with ASOCRET-KS/HB.



Consumption:  
 approx. 1.80 kg/m<sup>2</sup>/mm



	Article-No.	Color	Packaging size	Unit/Pallet
For conventional concrete repair.	2 06438001	grey	25 kg / bag	42



ASOCRET-BIS-1/6						
Mineral-based fine grain mortar for defects from 1 - 6 mm						
	<ul style="list-style-type: none"> <li>• Tested to DIN EN 1504-3.</li> <li>• Polymer modified, cement-based fine grain mortar.</li> <li>• For vertical and horizontal surfaces.</li> <li>• Impermeable to water.</li> <li>• Water vapour permeable.</li> <li>• Frostproof and resistant to de-icing salts.</li> <li>• Reduces CO<sub>2</sub> penetration.</li> <li>• Superior resistance to carbonation.</li> <li>• Used to repair concrete as a non-s slump reprofiling mortar for horizontal, vertical as well as „overhead“ areas with damage of 1 - 6 mm deep. Largest particle size: 0.5 mm.</li> <li>• As a levelling coat and a scratch coat.</li> </ul> <p>Consumption: Prepared mix: Approx. 1.6 kg/m<sup>2</sup>/mm thickness Approx. 1.0 l/mixture = 2.0 kg</p>					
	Article-No.	Color	Packaging size		Unit/Pallet	
Fine grain smoothing compound on to surfaces coated with ASOCRET-BIS-5/40.	2 06437001	grey	25 kg / bag	42		

ASOCRET-IM						
Repair mortar with crystalline sealing action for concrete						
	<ul style="list-style-type: none"> <li>• Capillary active mortar.</li> <li>• For the watertight filling of opened cracks and holes, which are subsequently to be covered with AQUAFIN-IC. Alternatively ASOCRET-IM can also be used to form coved fillets.</li> </ul> <p>Consumption: U-shaped cracks chiselled out to 20 x 25 mm, 1.3 kg/m. Coved fillets 38 mm haunches: approx. 1.3 kg/m.</p>					
	Article-No.	Color	Packaging size		Unit/Pallet	
Also suitable under negative water pressure.	2 05523001	grey	25 kg / bag	42		

## Products listed by name

Product	Page
AQUAFIN-IC	6
AQUAFIN-CA	10
AQUAFIN-CJ1	8
AQUAFIN-CJ3	9
AQUAFIN-CJ4	9
AQUAFIN-CJ5	7
AQUAFIN-CJ6	10
AQUAFIN-CJ-SET	8
AQUAFIN-EJ	12
AQUAFIN-EJ-WH/WRH	12
AQUAFIN-EJ-WR/WHF	11
AQUAFIN-P1	8
AQUAFIN-P4	9
AQUAFIN-PP-F	15
AQUAFIN-PP-W	15
AQUAFIN-WM12	14
ASOCRET-1/6	17
ASOCRET-5/40	16
ASOCRET-IM	6, 17
ASOCRET-KS/HB	16
ASO-Tape-2000-S	11
ASODUR-K4031	13
ASO-Tape	13
BETOCRETE-CL170-P	5
BETOCRETE-CL210-WP	5
BETOCRETE-CP350-CI	4
BETOCRETE-CP351-CI	4
BETOCRETE-CP360-WP	4
Fastening Mesh	10
FIX 20-T	6
Holding Clamp	7
Omega-Clamp, duplex	7

## Products listed by product groups

Product	Page	Product	Page
<b>Crystalline interior waterproofing</b>		<b>Waterproofing materials – movement joints</b>	
BETOCRETE-CP360-WP	4	AQUAFIN-EJ-WH/WRH	12
BETOCRETE-CP350-CI	4	AQUAFIN-EJ	12
BETOCRETE-CP351-CI	4	ASO-Tape	13
BETOCRETE-CL210-WP	5	ASODUR-K4031	13
BETOCRETE-CL170-P	5		
<b>Crystalline restructuring and exterior waterproofing</b>		<b>Waterproofing materials – sheet membranes</b>	
AQUAFIN-IC	6	AQUAFIN-WM12	14
FIX 20-T	6	AQUAFIN-CA	14
ASOCRET-IM	6		
		<b>Pipe penetrations</b>	
		AQUAFIN-PP-F	15
		AQUAFIN-PP-W	15
		<b>Concrete restoration</b>	
AQUAFIN-CJ5	7	ASOCRET-KS/HB	16
Holding Clamp	7	ASOCRET-BIS-5/40	16
Omega-Clamp, duplex	7	ASOCRET-BIS-1/6	17
AQUAFIN-CJ1	8	ASOCRET-IM	17
AQUAFIN-CJ-Set	8		
AQUAFIN-P1	8		
AQUAFIN-P4	9		
AQUAFIN-CJ3	9		
AQUAFIN-CJ4	9		
AQUAFIN-CJ6	10		
Fastening Mesh	10		
AQUAFIN-CA	10		
AQUAFIN-EJ-WR/WHF	11		
ASO-Tape-2000-S	11		

# We are there for you!

## Customer management:

















**central office:** Tel. 05231-953-124  
Fax 05231-953-6124

## Technical advice:

**central office:** Tel. 05231-953-584  
Fax 05231-953-155

## Explanation of the pictograms and abbreviations

\* = Minimum purchase quantity  
E.-Pal. = Europallet

	For walls		1-component
	For ceilings		2-component
	For floors		Approved by the construction inspectorate
	For interior		CE-approved
	For exterior		DUST REDUCING
	Vapour-tight		Radon-tight
	Open for vapour diffusion		EMICODE: EC1-PLUS approved
	Ready for use		EPD-certified – for sustainable construction

The SCHOMBURG group develops, produces and distributes construction materials systems for the areas of:

- Sealing/repairs to buildings
- Tiles/natural stone/screed application
- Ground protection/floor coating systems
- Concrete technology

For over 80 years SCHOMBURG's development competence has been a recognised feature in both the domestic and the worldwide marketplace. Construction materials systems that are produced in-house are highly prized around the world.

Experts value the quality and the efficiency of construction materials systems, the services and therefore the core competence of the group of companies.

In order to meet the demanding requirements of an ever-changing market, we are continuously investing in the research and development of new and existing products. This guarantees an ever increasing product quality to the satisfaction of our customers.

SCHOMBURG GmbH & Co. KG  
Aquafinstraße 2 - 8  
D-32760 Detmold (Germany)  
Telephone +49-5231-95 3-00  
Fax +49-5231-953-333  
[www.schomburg.com](http://www.schomburg.com)

